

SET UP INSTRUCTION FOR 300 DLX

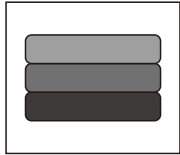

Flysheet

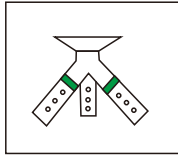

Three-Way Connector
x1pc

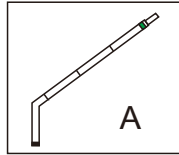

Leg Pole with
green Sticker x2pcs

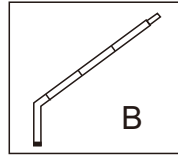

Leg Pole without
Sticker x1pc

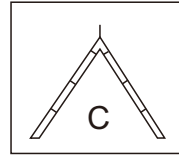

Door Pole x1pc

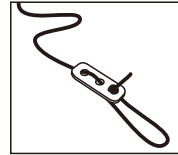

Guy Rope x10pcs

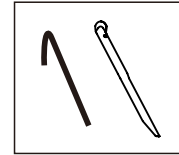

Pegs 5x21cm 11pcs
+21cm Corner Pegs 10pcs

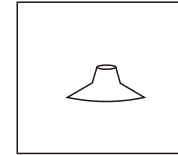

Rain Hat x1pc

1

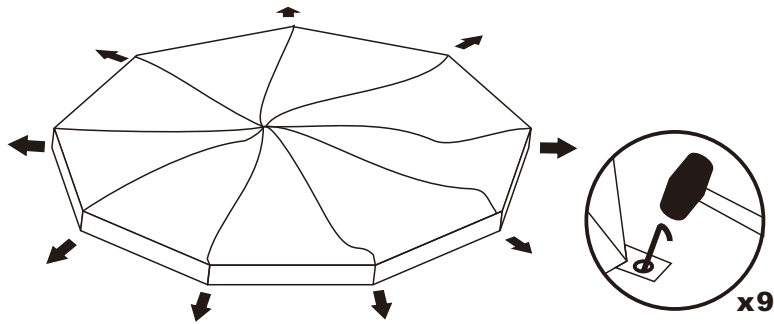

2

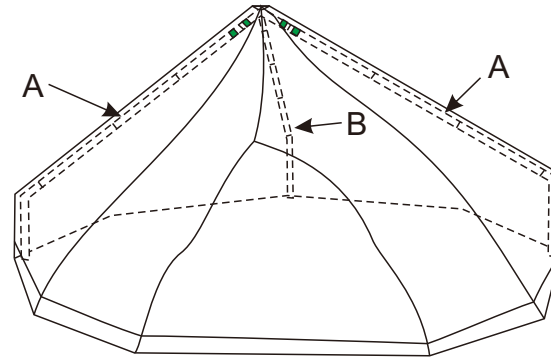

3

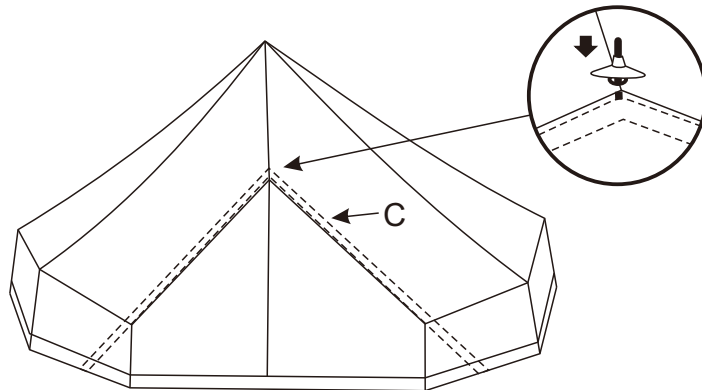

4

